

ELFOCONTROL² : Unità di controllo per impianti residenziali autonomi + convertitore ethernet/485 (3 moduli DIN)

AL12X : Alimentatore 230/1/50 – 12 VDC (4 moduli DIN)

CONVERTITTORE TTL/485 (2 moduli DIN)

KGPRX: modulo per gestione di un gruppo di miscelazione

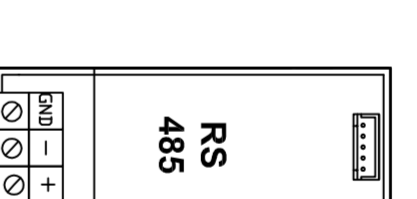
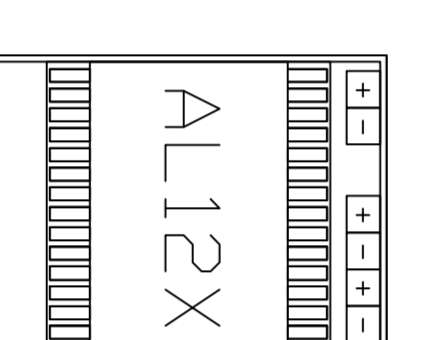
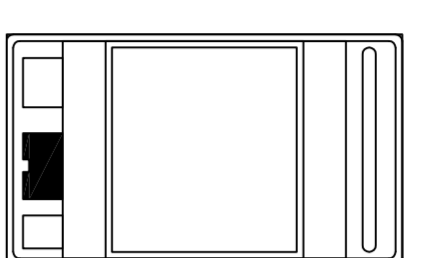

BMZRX: modulo per gestione fino a 6 termostati HID e 6 uscite di comando valvole di intercettazione (9 moduli DIN)

MIOX: modulo per gestione generatore di sostituzione (caldaia), valvole di zona o pompe di rilancio e consenso remoto (4 moduli DIN)

CMRSX: modulo per gestione di 1 termostatoI HID e 1 uscita di comando valvola di intercettazione (6 moduli DIN)

HIDT2X: Termostato solo temperatura – installazione a parete

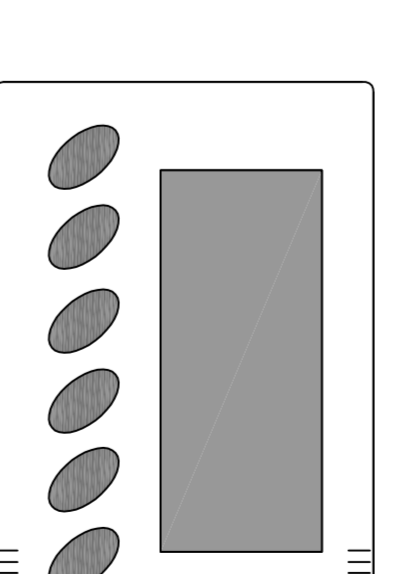
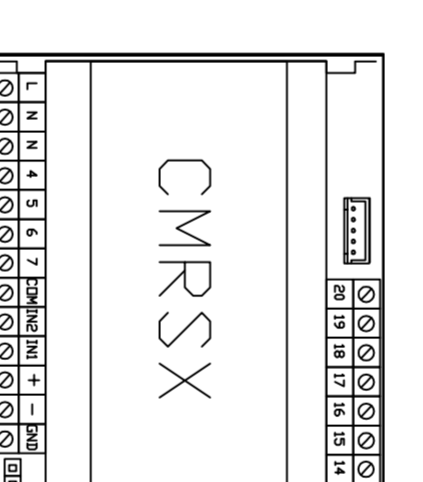
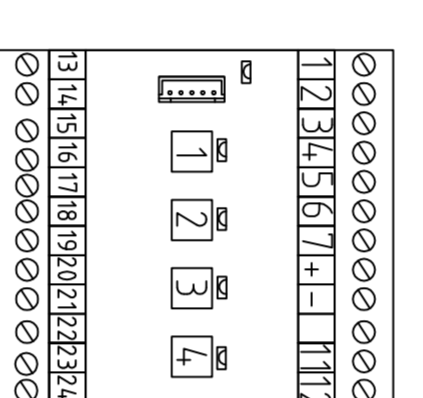
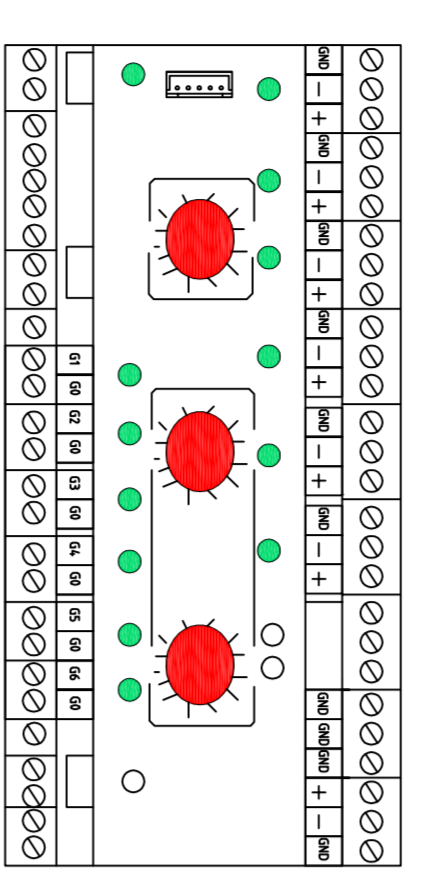

HID-T3X: Termostato temperatura ed umidità – installazione a parete

HIDT14BX: termostato solo temperatura–installazione ad incasso colore bianco e collegabile a sensore umidità

HIDURBX: sensore umidità – installazione ad incasso colore bianco e collegabile a termostato HIDT14BX

HIDT14NX: termostato solo temperatura–installazione ad incasso colore nero e collegabile a sensore umidità

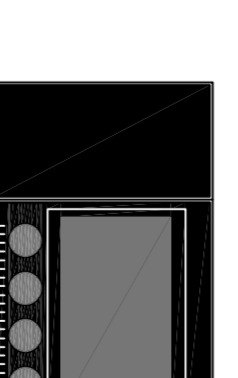
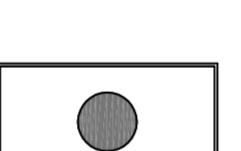
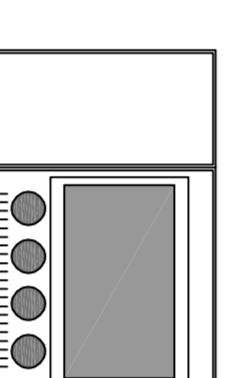
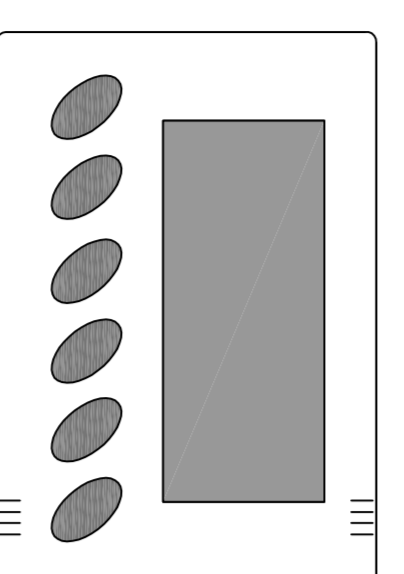

HIDURNX: sensore umidità – installazione ad incasso colore nero e collegabile a termostato HIDT14NX

HID-T12X: termostato solo temperatura ad incasso

HID-T15BX: termostato temperatura ed umidità di colore bianco con display touch screen per installazione ad incasso a parete

HID-T15NX: termostato temperatura ed umidità di colore nero con display touch screen per installazione ad incasso a parete

